

3LM*

CATÁLOGO
EXPOSITORES PUBLICITÁRIOS



Para informações adicionais sobre os produtos pode visualizar os vídeos explicativos utilizando o QR CODE correspondente.

Pode descarregar a aplicação gratuita **QR-Reader**.
Válida na Apple Store e Google Play.

ÍNDICE

SINALÉTICA E INFORMAÇÃO	04 - 21
ROLL-UPS	22 - 27
BANNERS	28 - 33
BALCÕES	34 - 41
PORTA-CATÁLOGOS	42 - 45
GESTORES DE FILA	46 - 49
POP-UPS	50 - 53
TOOL FREE MOBILE	54 - 65
TUBULAR FABRIC SYSTEM	66 - 69
BLACK TRUSS SYSTEM	70 - 77
SINAIS DE PAVIMENTO	78 - 83
BANDEIRAS	84 - 97
TENDAS	98 - 103
DIGITAL LED	104 - 111
STAND ON FLOOR	112 - 118

**SINALÉTICA +
INFORMAÇÃO**

PARA PAREDE

SLIM SIGN

PAREDES INFORMATIVAS

EASY SLIDE

SLIM DOUBLE SLIDE

PORTA FOLHETOS

PAINEL SANDWICH

PORTA MONO FOLHA

PORTA MONO FOLHA REUTILIZÁVEL

SNAP ECO

HANG LED FRAME

BLACK BRIGHT

DE BALCÃO

SEPARADOR ACRÍLICO

PORTA CARTÕES DE VISITA

PORTA MENU EM L

PORTA MENU + CARTÕES DE VISITA

PORTA MENU BASE ALUMÍNIO

PORTA MENU EM T

CAIXA DE SUGESTÕES

MULTI EXPOSITOR DE FOLHETOS

PARA SUSPENSÃO

CEILING FRAME

CABO SUSPENSÃO

DE MONTRA

SISTEMAS CABOS DE AÇO

LIGHTBOX

DE FACHADA

SISTEMA MASTERY FRAME

PARA PAREDE

VEJA O VÍDEO



saiba mais

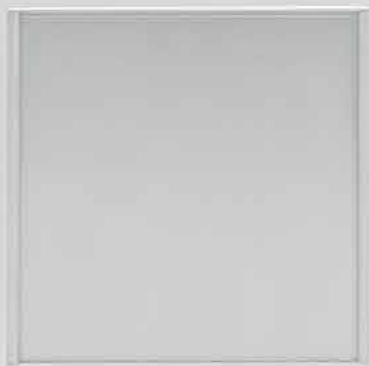

SLIM SIGN | A5 | A4 | A3 | 180X80 | 170X70 | 160X60 | 420X594

VEJA O VÍDEO



saiba mais



VEJA O VÍDEO



saiba mais



EASY SLIDE | 250 | 500 | 750 | 1000

8



SLIM DOUBLE SIDE | 148X148 | 210X210



PORTA FOLHETOS VERT. | A5 | 1/3 A4 | A4

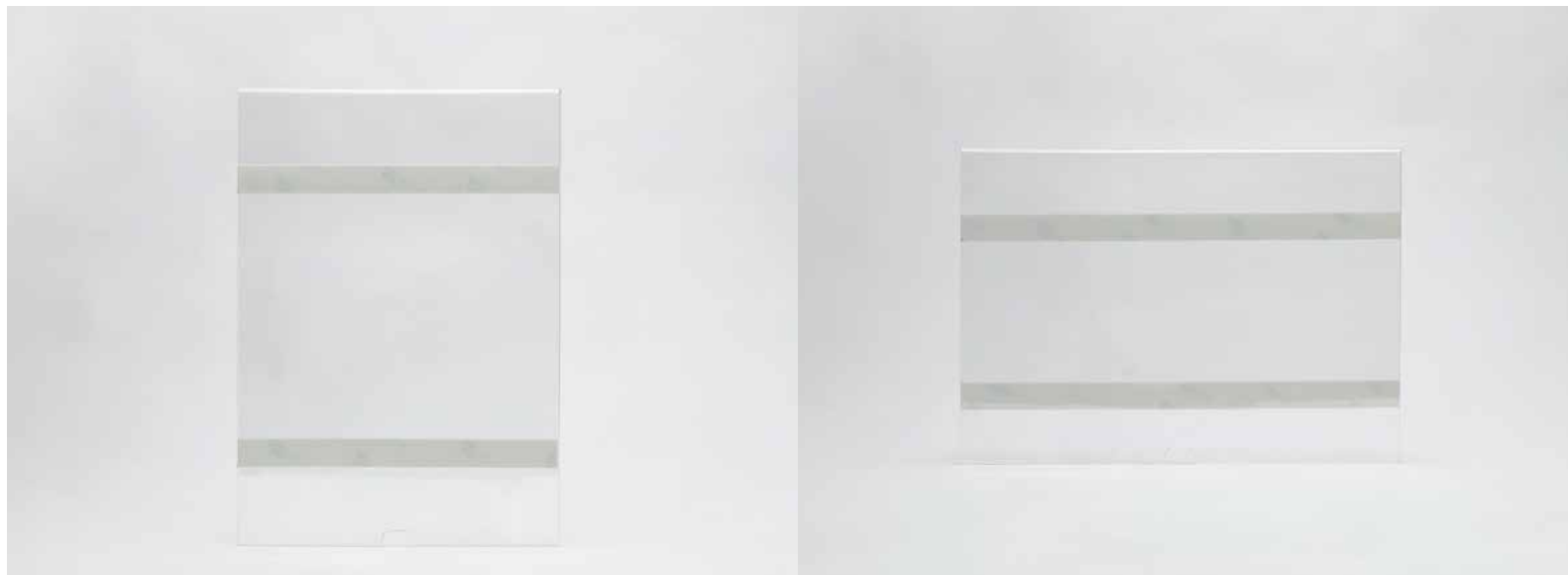

PAINEL SANDWICH VERT. / HORIZ. | C/ ADESIVO | C/ DEDEIRA | A0 | A1 | A2 | A3 | A4 | A5



PORTA MONO FOLHA VERT. / HORIZ. | C/ ADESIVO C/ A4 | A3

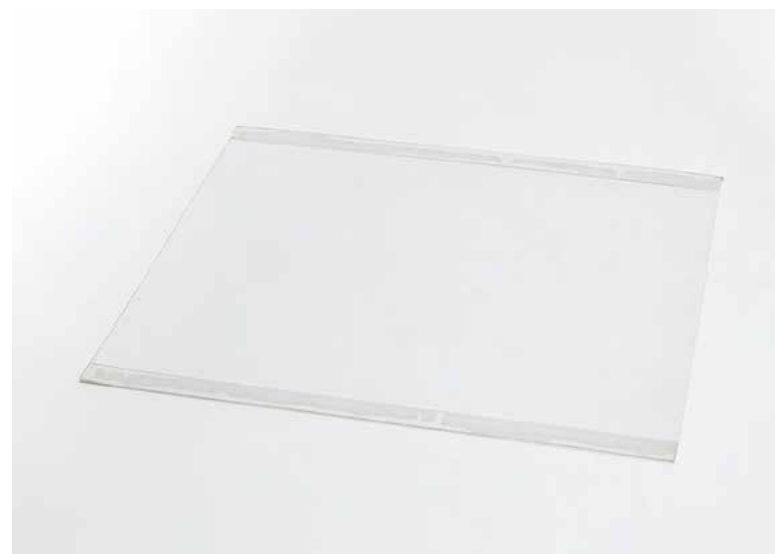

PORTA MONO FOLHA REUTILIZÁVEL VERT. / HORIZ. | C/ ADESIVO | A4 | A3

PARA PAREDE

VEJA O VÍDEO



saiba mais



SNAP ECO 25 | A5 | A4 | A3 | A2 | A1 | A0 **SNAP ECO WHITE** | A4



HANG LED FRAME | A4 | A3 | A1



BLACK BRIGHT FRAME | A2 | A3 | A4

12



SEPARADOR ACRÍLICO | 60X60 | 60X80



PORTA MENU C/ BASE DE ALUMÍNIO | VERT. / HORIZ. A5 | 1/3 A4 | A4



PORTA CARTÕES DE VISITA

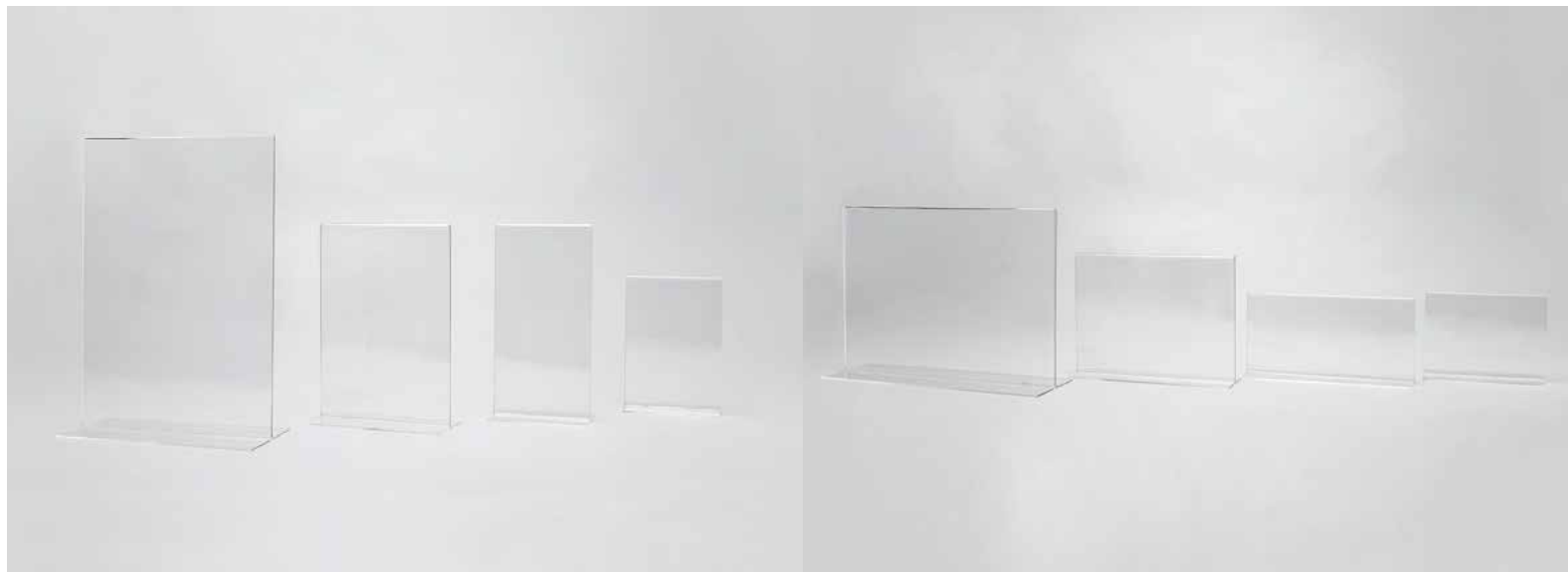

PORTA MENU EM T | VERT. / HORIZ. | A6 | A5 | 1/3 A4 | A4

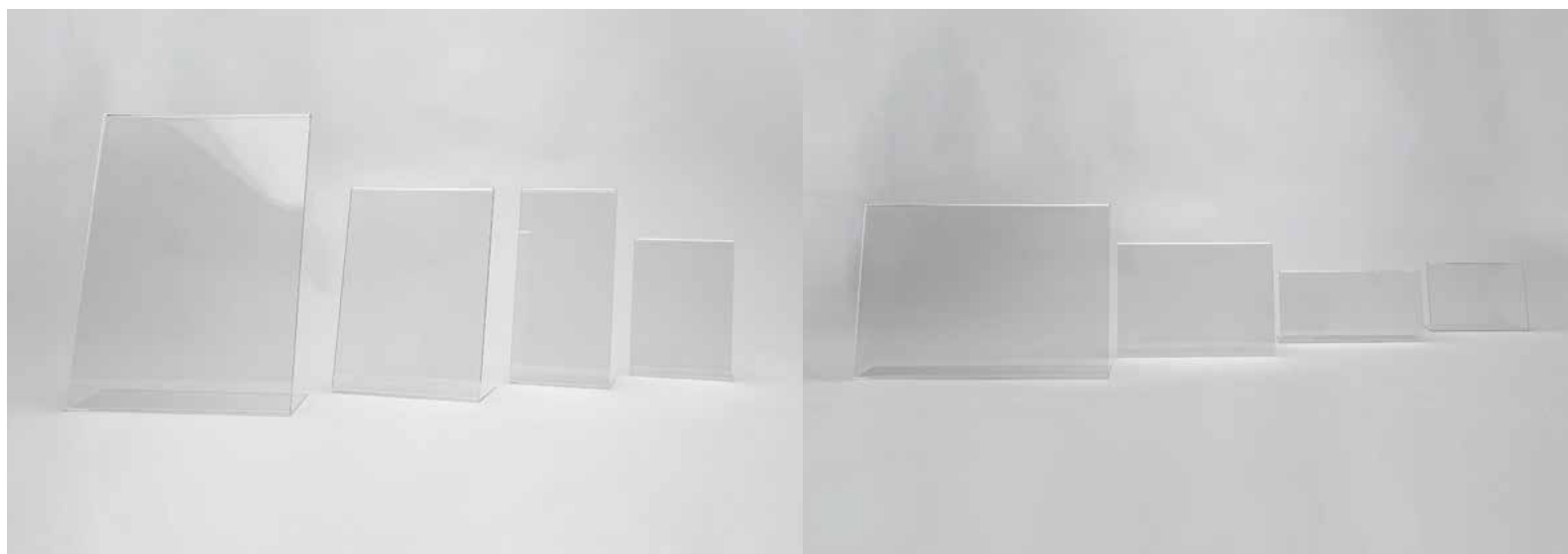

PORTA MENU EM L | VERT. / HORIZ. | A6 | A5 | 1/3 A4 | A4

14



CAIXA DE SUGESTÕES | C/ FECHADURA | 15X15X15 | 22X22X22

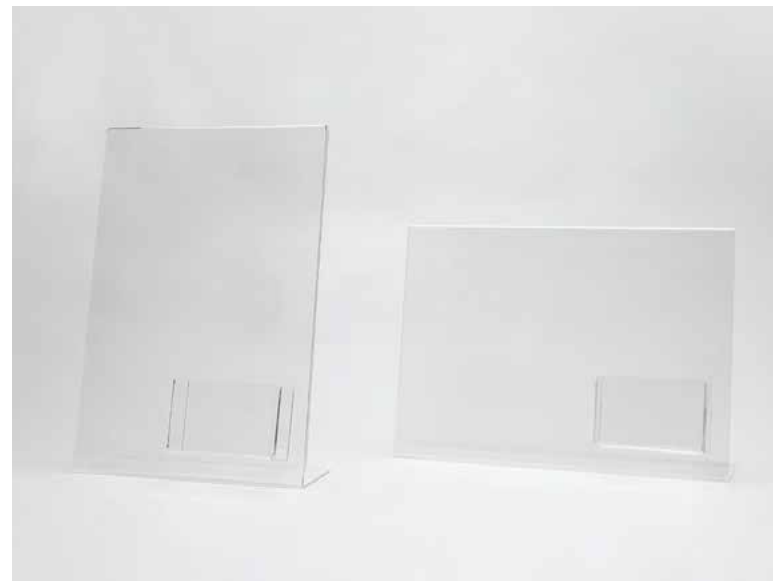

PORTA MENU + PORTA CARTÕES | A4



MULTI EXPOSITOR DE FOLHETOS | VERT. | 3 NÍVEIS
A5 | 1/3 A4 | A4



CABO SUSPENSÃO P/ SIN ALÉTICA

A4 | A5 | 600X150 | 450X150 | 400X200 | 300X15 |
150X250 | 300X100



CEILING FRAME | 550X210 | 850X300



SISTEMAS DE CABOS DE AÇO | A0 | A1 | A2 | A3 | A4 | A5

DE MONTRA

VEJA O VÍDEO



saiba mais

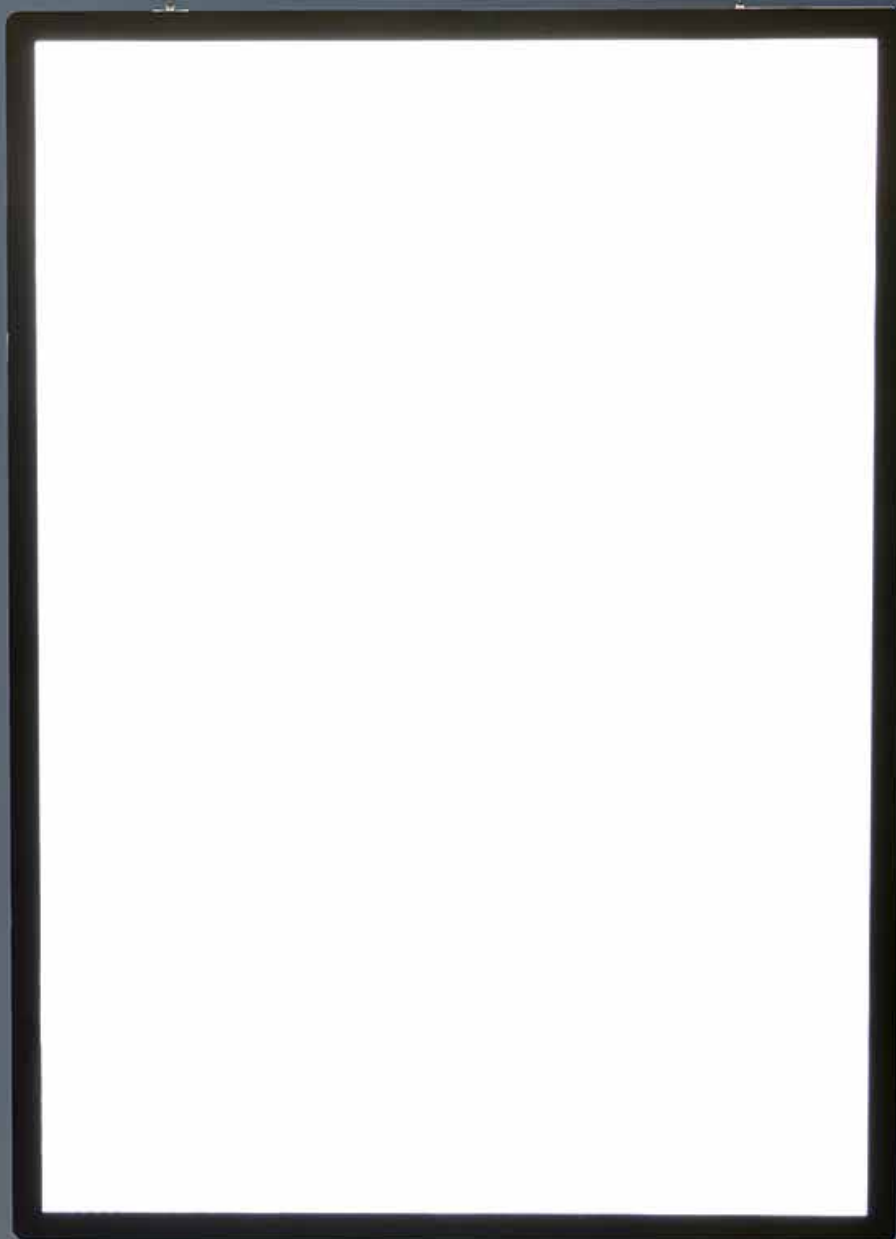

LIGHTBOX S3 | A0 | A1 | A2 | A3 | A4



FONTE DE ALIMENTAÇÃO EXTERNA | 150W 24V 6.25A
CABO DE LIGAÇÃO S3 | À FONTE DE ALIMENTAÇÃO



PACK 2X CABO DE LIGAÇÃO DUPLO
LIGHTBOX S2



PERFIL CARRIL ELECTRIFICADO S3



CABO DE AÇO 2.4M | SUSPENSÃO PERFIL S3

18



PERFIL DE ALUMÍNIO C/ VIA 3.1M



SISTEMA MASTERY FRAME | SUPORTE CANTO 90°



SUPORTE PAREDE | C/ PARAFUSOS



LIGADOR PERFIL T



LIGADOR PERFIL 0°



ACESSÓRIO PRODUÇÃO
BOTÃO | GANCHO PLÁSTICO

ROLL-UPS

SHOP W40

CLASSIC + SIMPLE BAG

CLASSIC + REINFORCED

EVOLUTION +

DOUBLE SIDE DUAL

PERFORMANCE

PERFORMANCE

DOUBLE SIDE EXTERIOR

DOUBLE QUAD PREMIUM

GEOMETRIC BLACK

INFINITY

22



SHOP W40 | 40



CLASSIC + SIMPLE BAG | 85 | 100 | 120



CLASSIC+ REINFORCED | 85 | 100



EVOLUTION + | 85 | 100 | 120 | 150



24



DOUBLE SIDE DUAL | 85 | 100



PERFORMANCE | 150 | 200



DOUBLE QUAD PREMIUM | 85



GEOMETRIC BLACK | 85



BANNERS

CHAIR SCREEN BANNER

INFO PANEL BLACK

POSTER PANEL

ADJUSTABLE BACKDROP

SOLO DISPLAY

X-BANNER

VEJA O VÍDEO



saiba mais



CHAIR SCREEN BANNER MEDIUM | 155X155 / SMALL | 110X110



INFO PANEL BLACK | 50x170



POSTER PANEL DUPLA FACE | 60X150

30



ADJUSTABLE BACKDROP S2 | (larg.) 108 A 314 | (alt.) 110 A 299



SOLO DISPLAY DUPLA FACE | 60X180

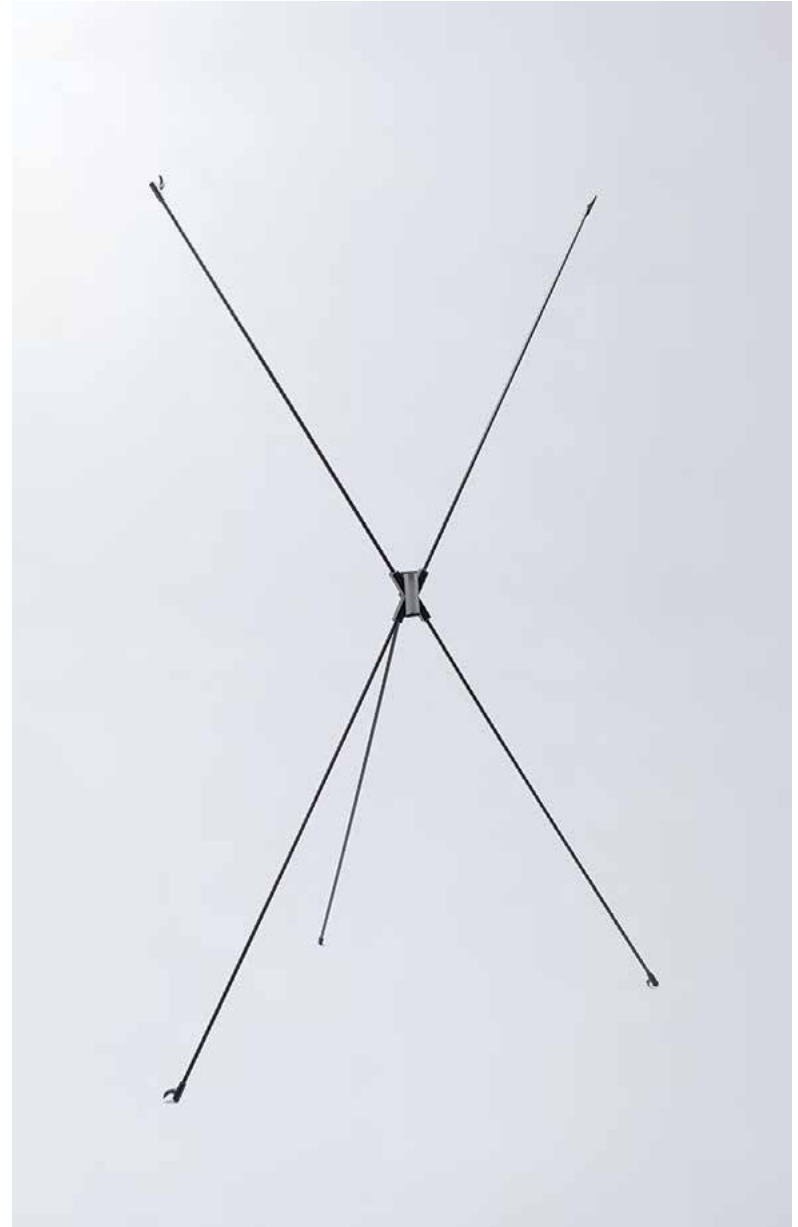

X-BANNER IMPROVED S2 | 160X60 | 180X80

BALCÕES

PROMO A

PROMO B

PRODUCT PLACER ROUND

PANEL TRACK

POWER SPOT MINI

POWER SPOT MAXI

TUBULAR FABRIC SYSTEM SQUARE

TOOL FREE MOBILE STAND

34



PROMO A | 182.5X85 / 78X28



PROMO B | 141X85 / 78X28



PRODUCT PLACER ROUND | 130X92 cm

36



PANEL TRACK | 182X92 cm | inclui prateleira

VEJA O VÍDEO



saiba mais



DESIGN REGISTRADO · PRODUTO EXCLUSIVO WEDDT.

POWER SPOT MINI | 130x105

Registo Design | nº 006433512-0003 | www.euipo.europa.eu



DESIGN REGISTRADO · PRODUTO EXCLUSIVO WEDDT.

POWER SPOT MAXI

Registo Design | nº 006433512-0003 | www.euipo.europa.eu

VEJA O VÍDEO



saiba mais



TUBULAR FABRIC SYSTEM SQUARE | 220X102





TOOL FREE MOBILE STAND | 100x100

PORTA CATÁLOGOS

BLACK

CASCATA ACRÍLICA

BASE PRETA

42

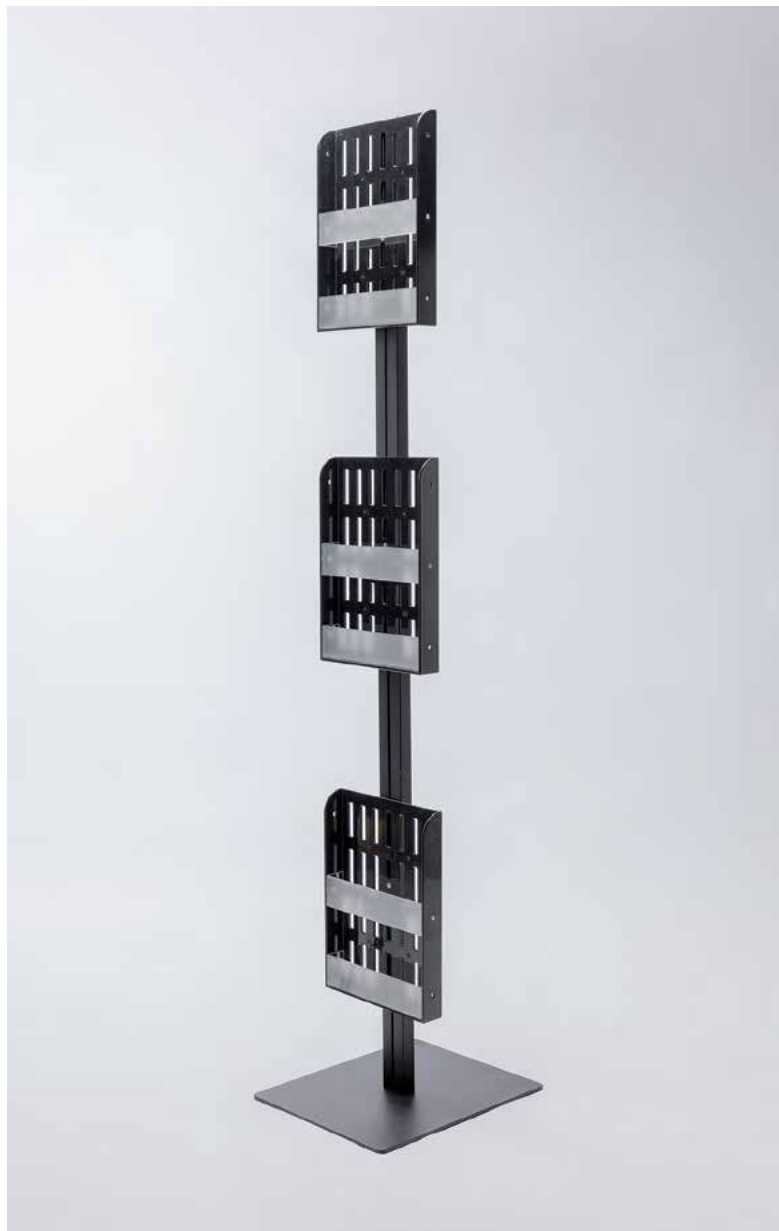

PORTA CATÁLOGOS BLACK | A4



PORTA CATÁLOGOS CASCATA ACRÍLICO | A4 | 153X25



PORTA CATÁLOGOS BASE PRETA | A4 | 145X23

GESTORES DE FILA

PACK 2X Q-LINE ELEGANCE

Q-LINE STANDARD MIRROR

Q-LINE STANDARD BLACK SERIES

CINTA DE FIXAÇÃO DE PAREDE SS



PACK 2X Q-LINE ELEGANCE MIRROR | 1500 | CROWN TOP



Q-LINE STANDARD MIRROR | 3000



Q-LINE STANDARD BLACK SERIES | 3000



CINTA DE FIXAÇÃO DE PAREDE SS
MIRROR | BLACK

POP-UPS

CLÁSSICO S2 RECTO / CURVO

TÊXTIL RECTO

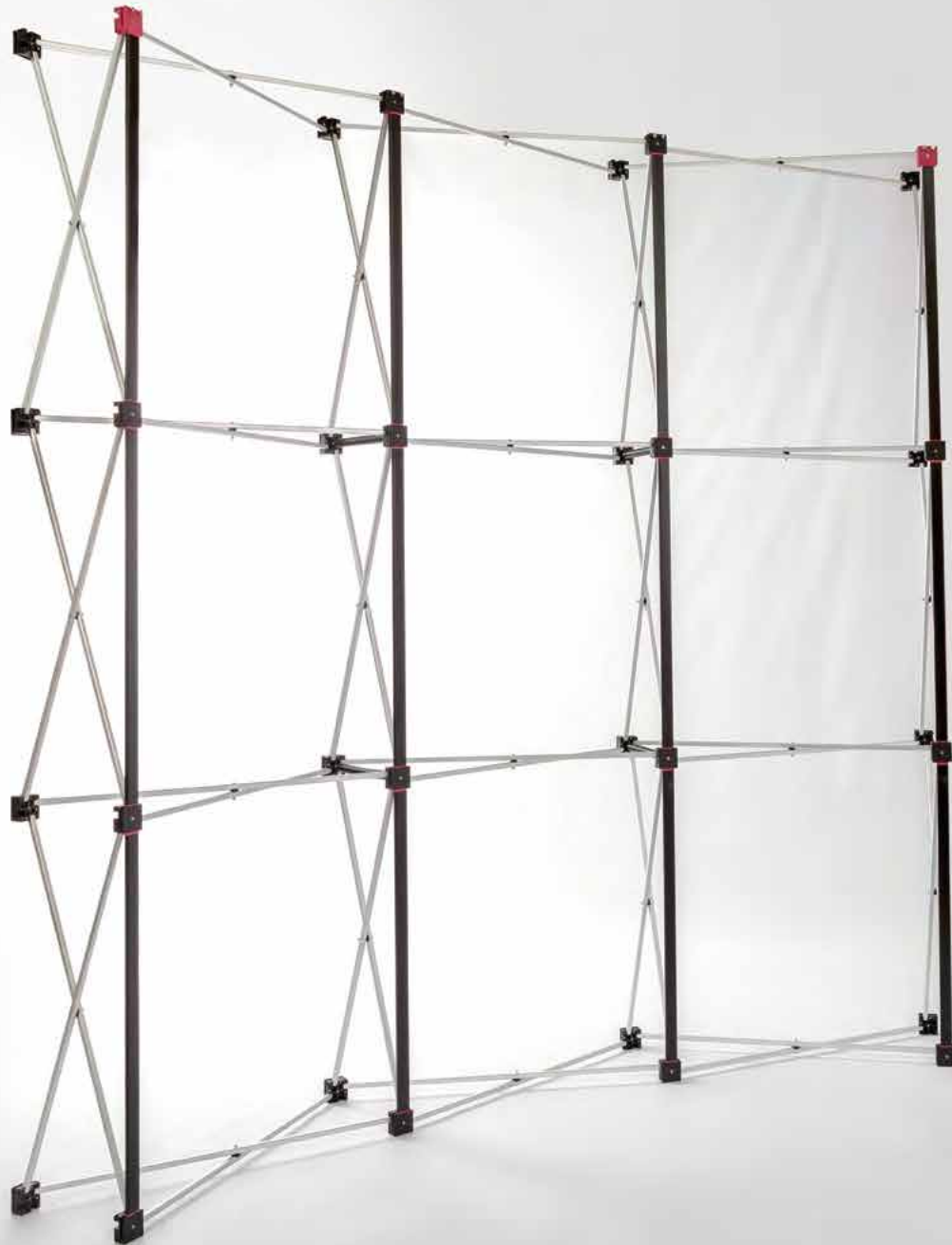

CLÁSICO S2 | RECTO / CURVO | 3X3 | 4X3



**TOOL FREE
MOBILE**

PARA PAREDE

SMART 20

LED MOBILE STAND BACKLIGHT

PARA CHÃO E SUSPENSÃO

CUBO 3D

LED MOBILE STAND

LED MOBILE STAND BACKLIGHT

TOOL FREE

01
APTO PARA
RETROILUMINAÇÃO

02
FÁCIL DE MONTAR E
TRANSPORTAR
TOOL FREE

03
ACESSÓRIOS QUE
POSSIBILITAM VÁRIAS
COMBINAÇÕES

04
PRODUÇÃO TÊXTIL





01

sistema 01
MÓDULO DE LEDS

sistema 02
CORTINA DE LEDS

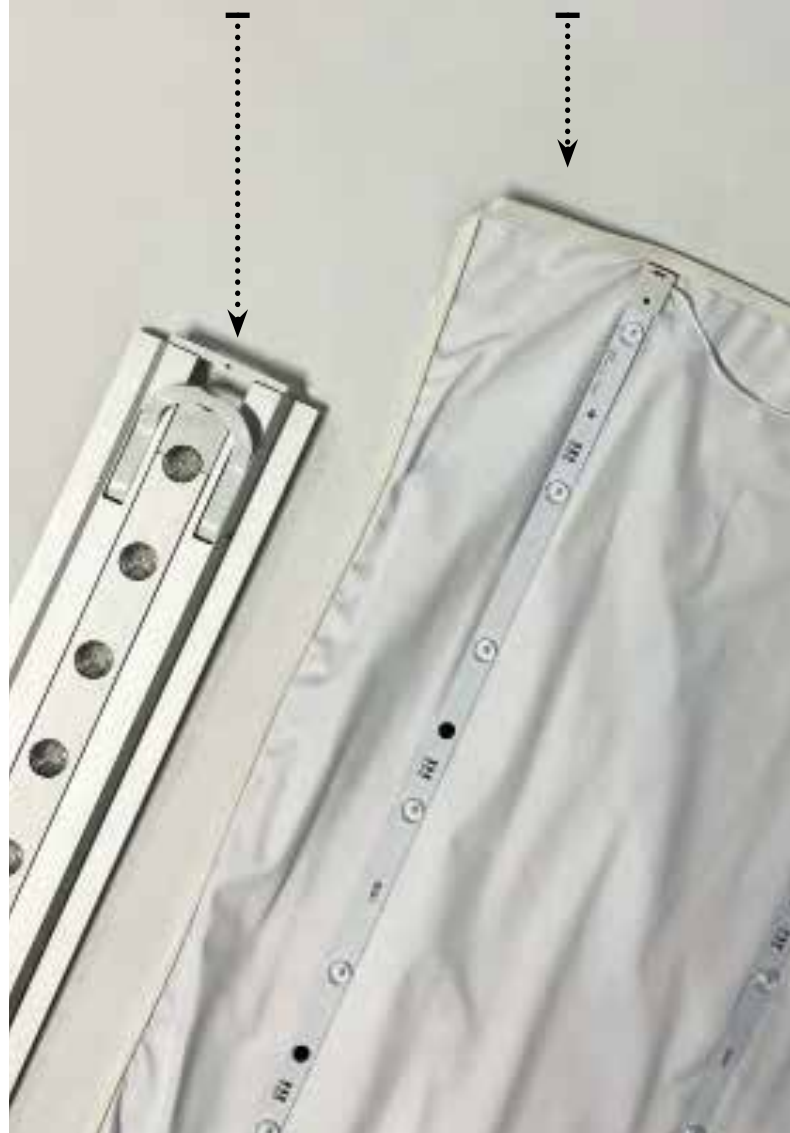

02



SISTEMA "CLICK CLACK"
Não é necessária a utilização
de ferramentas

MALA DE TRANSPORTE
Com rodas para facilidade de
deslocação



03

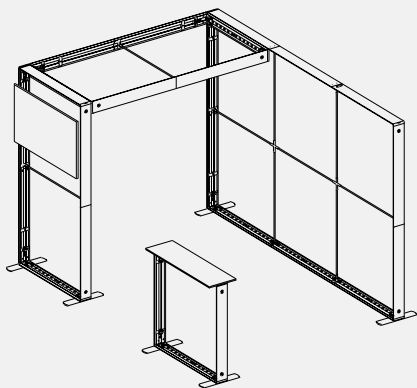

OS ACESSÓRIOS PERMITEM
DIFERENTES COMBINAÇÕES
E FUNCIONALIDADES

- 01 Prateleiras
- 02 Peças de ligação
- 03 Suportes de ecrãs.

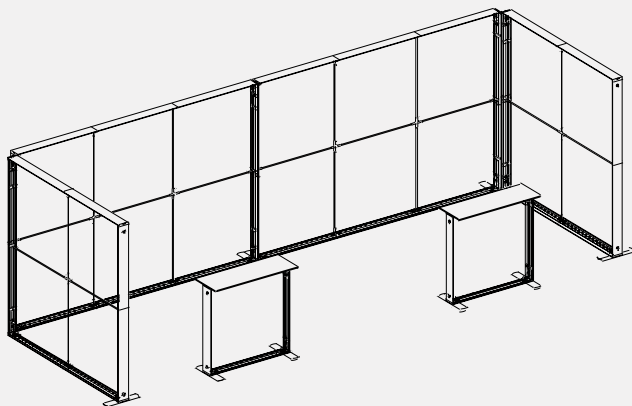
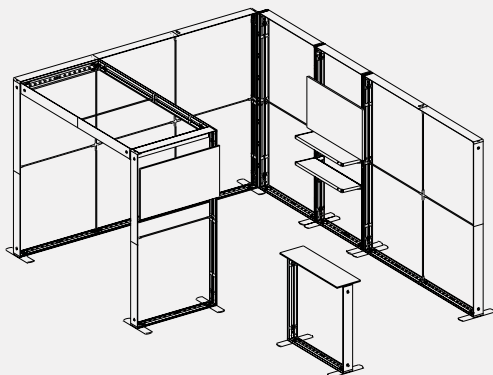

04



PARA PAREDE



SMART 20 | 100X200



LED MOBILE STAND BACKLIT | 50X150 | 85X200 | 100X200

60



CUBO | 100X100 | 200X200

VEJA O VÍDEO



saiba mais



LED MOBILE STAND BACKLIT | 50X150 | 85X200 | 100X200

62



MOBILE STAND | 50X150 | 100X250 | 200X250 | 300X250

PARA CHÃO



INFO ADICIONAL



saiba mais

TUBULAR FABRIC SYSTEM

TUBULAR FABRIC SYSTEM RECTO

TUBULAR FABRIC SYSTEM CURVO

INFO ADICIONAL



saiba mais

66



TUBULAR FABRIC SYSTEM | CURVO | 300x228

INFO ADICIONAL



saiba mais



TUBULAR FABRIC SYSTEM | RECTO | 292x228

BLACK TRUSS SYSTEM

TRUSS 15 MODUL BLACK

CORNER BLOCK BLACK

CONECTOR CROSS BLACK

PACK 2X FOCO

REGULAR BASE BLACK

MIDDLE BASE BLACK

SIDE BASE BLACK

01

.....
**MONTAGEM SIMPLES E
TOOL FREE**

02

.....
FÁCIL DE TRANSPORTAR

03

.....
VERSÁTIL E MODULAR

04

.....
**SOFTWARE 3D GRATUITO
PARA SIMULAÇÃO DAS
ESTRUTURAS**

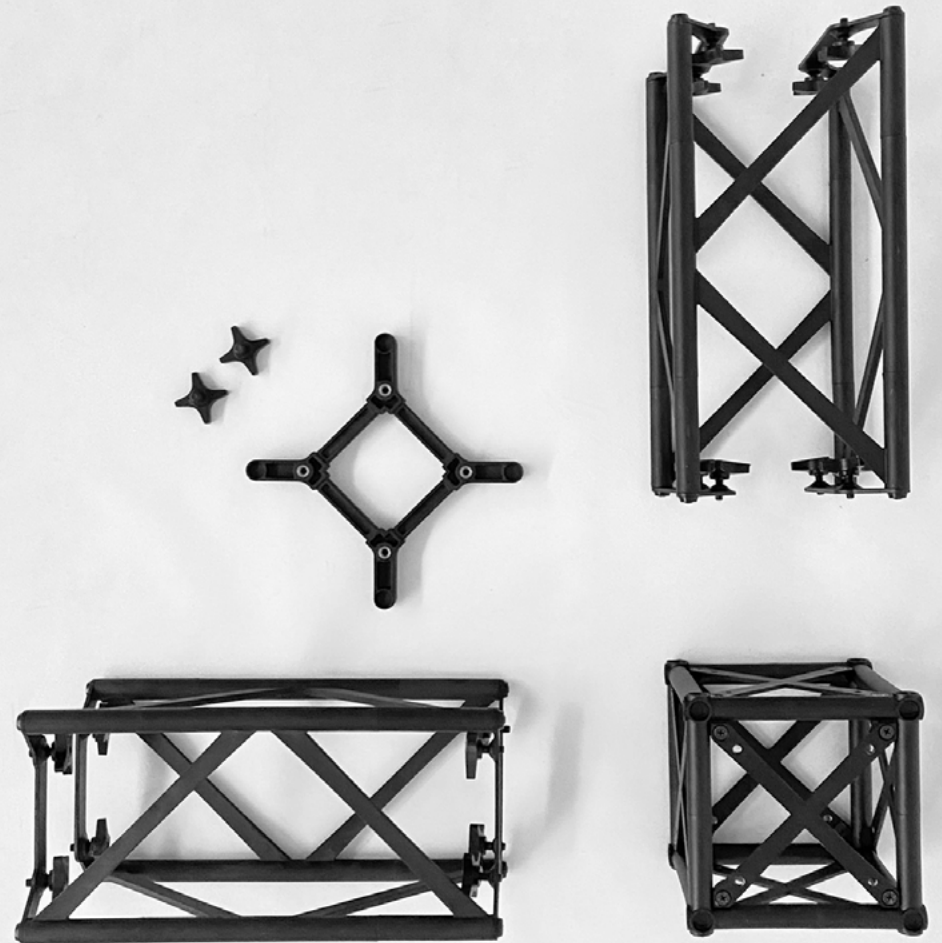







01



02



ESTRUTURAS REBATÍVEIS

Simplificação do transporte e redução do espaço de armazenagem.

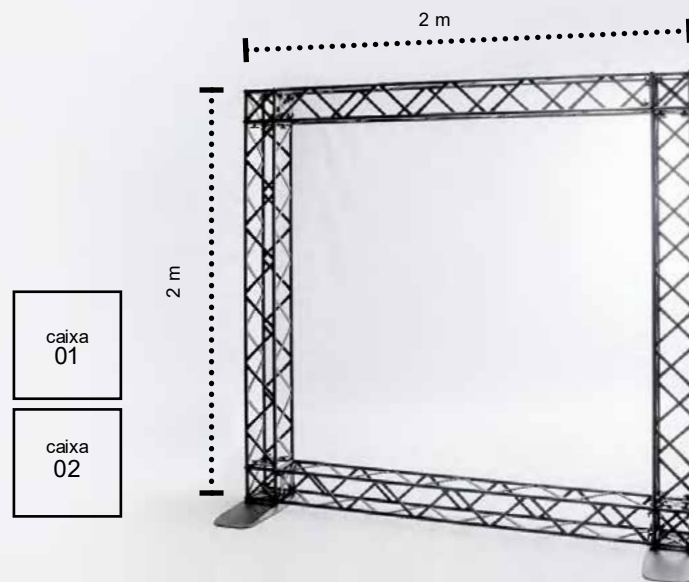

PAREDE MONTADA COM 2M X 2 M

componentes: 4 CUBOS + 4 BARRAS 1500 + 2 BASES

embalamento: 2 EMBALAGENS 1 caixa 83X16X16 cm | 1 caixa 153X30X21 cm

03

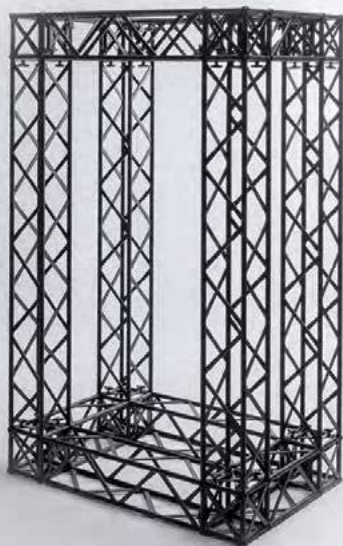
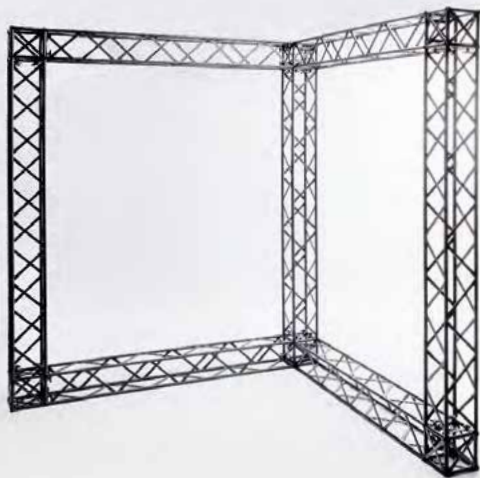

04

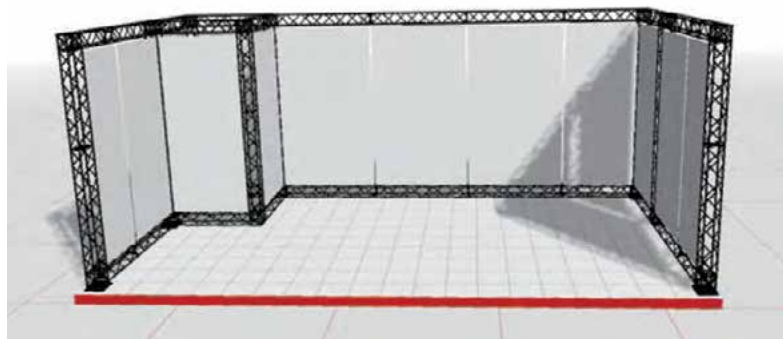

Simule as estruturas,
das mais simples às mais complexas.

.....
Teste a viabilidade das suas ideias
.....

Apresente ao seu cliente uma simulação
tridimensional do que pretende executar
.....

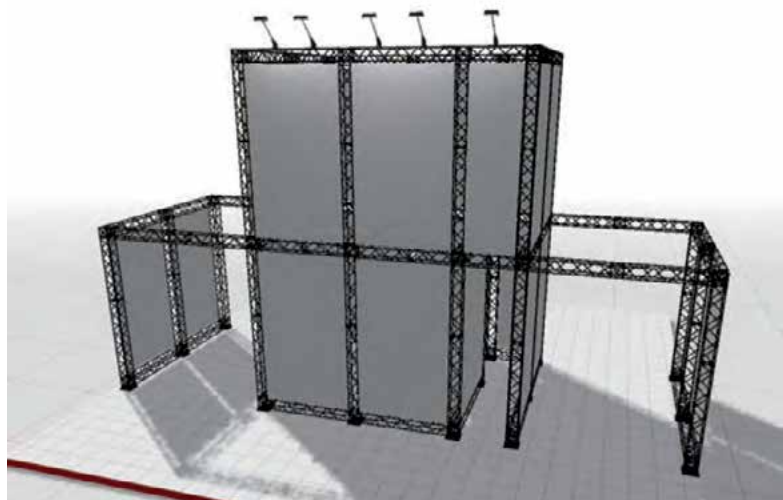

VEJA O VÍDEO



saiba mais



TRUSS 15 MODUL BLACK | 300 | 600 | 900 | 1200 | 1500



CORNER BLOCK BLACK



CONECTOR CROSS BLACK



PACK 2X FOCO
LED SILVER 24W | LED WHITE 11W | BASIC 150W



REGULAR BASE BLACK



SIDE BASE BLACK



MIDDLE BASE BLACK

SINAIS DE PAVIMENTO

TANKLED 20L 4x1

PANEL TRAP 30 | 60 | 80

CAVALETE ÍMAN SQUARE | ROUND

CAVALETE ECONÓMICO | A1 | B1

CAVALETE DUPLA FACE S2 | A1 | B1

SWING POSTER STAND S2

OUTDOOR POSTER STAND S2

A-FRAME

BARREIRA CONNECT

STOPPER

TUNNEL

80



TANKLED 20L 4x1



PANEL TRAP GREY | 30 | 60 | 80



CAVALETE ÍMAN | SQUARE | ROUND



CAVALETE ECONÓMICO | A1 | B1



CAVALETE DUPLA FACE S2 | A1 | B1



SWING POSTER STAND S2 | A1 | A0

82



OUTDOOR POSTER STAND S2 | A1 | A0



A-FRAME | HORIZ. | 130X70 | 200X90 | 250X110



BARREIRA CONNECT DUPLA FACE | BASES NÃO INCLUÍDAS



+ **CONECTOR EM T** permite unir várias barreiras



STOPPER | 125X155



TUNNEL | 500X300

BANDEIRAS

BANDEIRAS

GIANT RECTA 5.6M

SMALL

ROUND FRAME

MOCHILA C/ MASTRO S2

PACK PROMO 2.0

GOTA

WING

RECTA

SPIKE

3D CHAMA | CUP

INO

ROUND

BASES

X-ECONÓMICA FLOOR

X-FLOOR 4KG

BASE BLACK FLAT S2

BASE ROSCA

BASE ESPETO

FIXAÇÃO 0 | 25 | 90

FIXAÇÃO CERCA S2

BASE CARRO

BASE PIRÂMIDE

FIXAÇÃO POSTE

ROUND WATER BAG

BASE CIMENTO 10KG

TANKLED 13L | 20L | 20L 4x1

86



GIANT RECTA | 5.6 | C/ BASE GIANT PIRÂMIDE



SMALL | CLIP | VENTOSA | CARRO



ROUND FRAME | 0.6



MOCHILA C/ MASTRO S2 | GOTA | WING | RECTA

88



PACK PROMO 2.0 | GOTA | WING | C/ BASE INCLUÍDA



GOTA | 2.2 | 3.5 | 4.8 / 4.7 | 5.7 | 6.7



WING | 2.4 | 3.4 | 4.7 / 5.3 | 6.3 | 7.3



RECTA | 2.1 | 3 | 4.2 / 5.6

90



SPIKE | 2.5 | 3.4 | 4.7



3D CHAMA C/ LED
CUP S/ LED



INO | 1.48



ROUND | 2.1 | 2.6



92

BLACK FLAT S2 | 5KG c/ PINO | 15KG c/ ROTADOR



X-ECONÓMICA FLOOR C/ PINO | **X-ECONÓMICA PLUS** C/ ROTADOR



BASE ROSCA C/ ROTADOR | STANDARD | STRONG

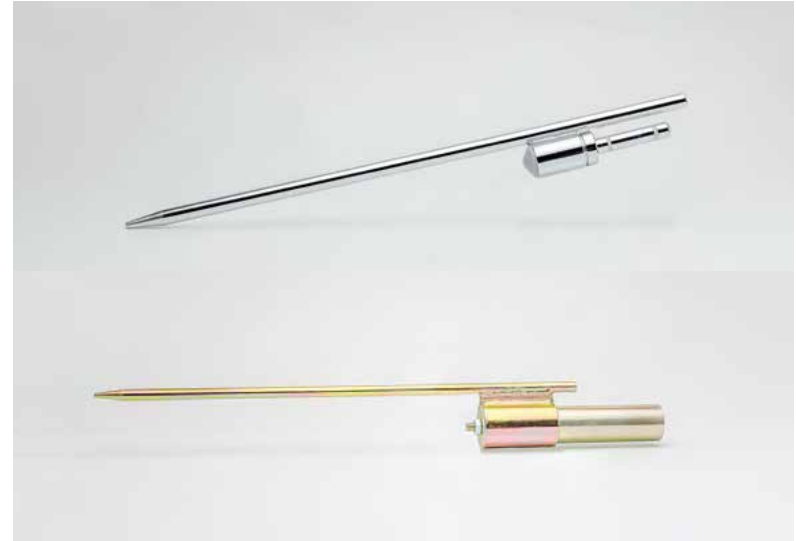

BASE ESPETO C/ ROTADOR | STANDARD | STRONG



X-FLOOR 4KG C/ ROTADOR | STANDARD | STRONG

94



BASE CARRO C/ ROTADOR | STANDARD



FIXAÇÃO CERCA S2 | C/ ROTADOR STANDARD



FIXAÇÃO 25° | 90° | 0° | C/ ROTADOR STANDARD



FIXAÇÃO POSTE C/ ROTADOR | STANDARD



TANKLED 13L C/ ROTADOR | STANDARD | C/ LED

TANKLED 20L C/ ROTADOR | STANDARD | C/ LED



TANKLED 13L C/ ROTADOR | STRONG | C/ LED



TANKLED 20L C/ ROTADOR | STRONG | C/ LED

VEJA O VÍDEO



saiba mais



96

TANKLED 20L 4x1 C/ ROTADOR | STANDARD | STRONG | C/ LED



TANKLED 13L C/ ROTADOR | STANDARD



TANKLED 20L C/ ROTADOR | STANDARD



TANKLED 20L 4X1 C/ ROTADOR | STANDARD



BASE GIANT PIRÂMIDE

ACESSÓRIOS



ROUND WATER BAG | 15L



BASE CIMENTO BLACK | 10KG

TENDAS

XA SERIES

MALA DE TRANSPORTE

SUPORTE 1/2 PAREDE

PESO 10 KG

SACO AREIA 35KG

BASE BANDEIRA C/ ROTADOR

100



XA SERIES | 3X3 | 3X4.5 | 3X6

Tecto, Paredes e Portas Opcionais



CORES DISPONÍVEIS



SUPORTE 1/2 PAREDE

102



MALA DE TRANSPORTE



PESO 10KG



SACO AREIA 35 KG



BASE BANDEIRA C/ ROTADOR | STANDARD

DIGITAL LED SYSTEM

OUTDOOR LED DISPLAY P4

INDOOR LED WALL P2.5

INDOOR LED POSTER P3

01

**SISTEMA MODULAR
INTERIOR E EXTER**

02

ACESSO REMOTO - WI-FI

03

PERMITE A UTILIZAÇÃO DE SOM

04

**SUPORTA IMAGEM OU VÍDEO
LIGAÇÃO HDMI IDEAL PARA
APRESENTAÇÕES EM TEMPO
REAL (exclusivo Indoor Led
Poster P3)**



01

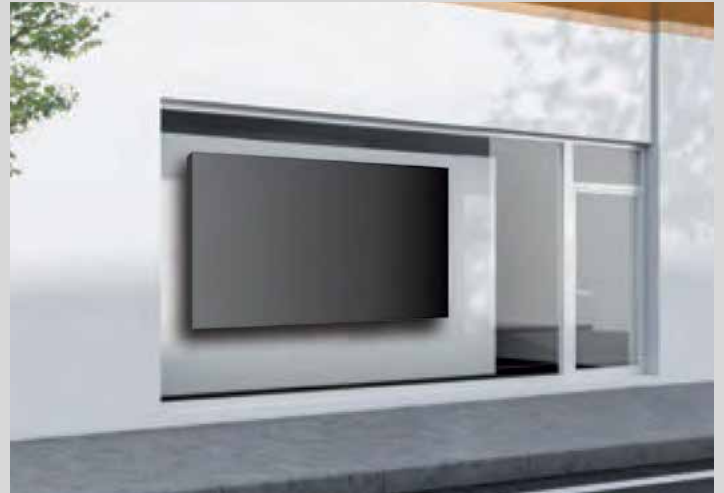

02

ACESSO REMOTO
A TODOS OS EQUIPAMENTOS
(indoor e outdoor)

.....
Comunicação através de wi-fi



03



**OS EQUIPAMENTOS PODEM
SER DOTADOS DE SOM**
desde que sejam conectados a
COLUNAS EXTERIORES

04



exclusivo
Indoor Led Poster
P3



ADEQUADO PARA
APRESENTAÇÕES



110



OUTDOOR LED DISPLAY P4



INDOOR LED WALL P2.5



INDOOR LED POSTER P3

**STAND ON
FLOOR**

PACK STAND ON FLOOR m2

STAND ON BASE 50 X 50

STAND ON TAMPA TRANSPARENTE 50 X 50

STAND ON RAMPA CANTO CURVO

STAND ON RAMPA LATERAL

STAND ON PERFIL ALUMÍNIO REMATE LATERAL

STAND ON CONECTOR PLÁSTICO

ISOLAMENTO ANTI-ESTÁTICO

01

.....
TORNA INVISÍVEL A
PASSAGEM DE CABOS



02

.....
FÁCIL DE TRANSPORTAR E
ARMAZENAR



03

.....
SUPPORTA ATÉ 3600Kg / M2



04

.....
TRANSFORMA O PAVIMENTO
NUM MEIO DE COMUNICAÇÃO



05

.....
FÁCIL DE MONTAR
TOOL FREE



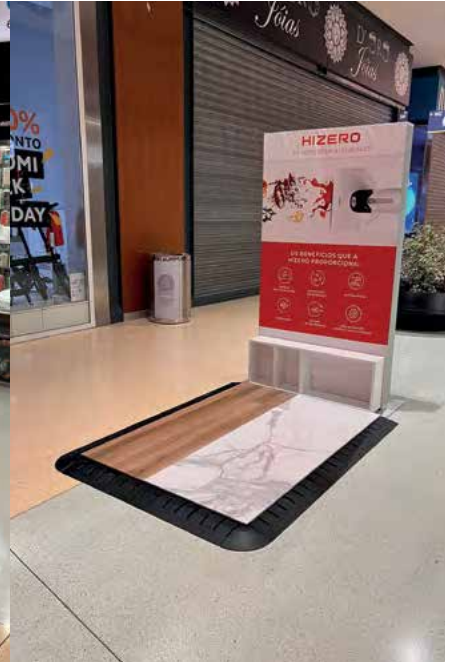

01



02

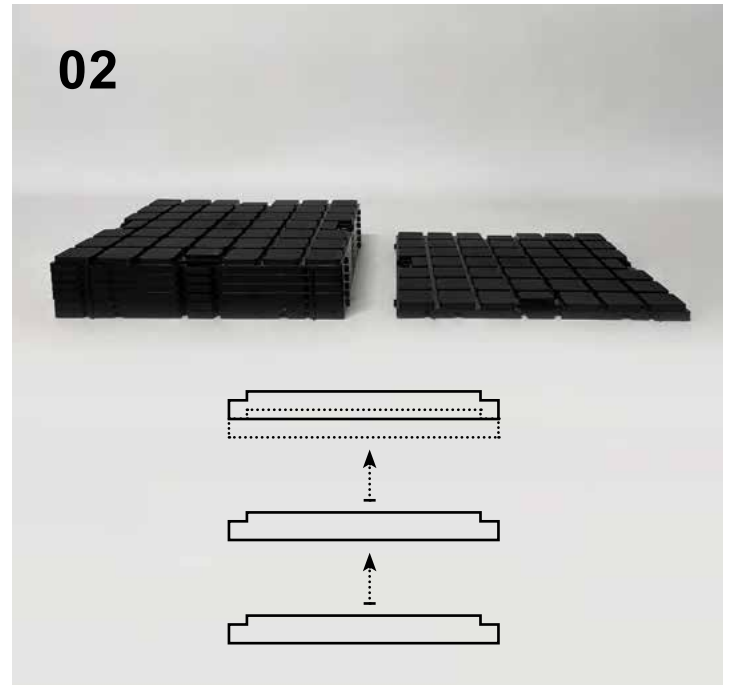

03

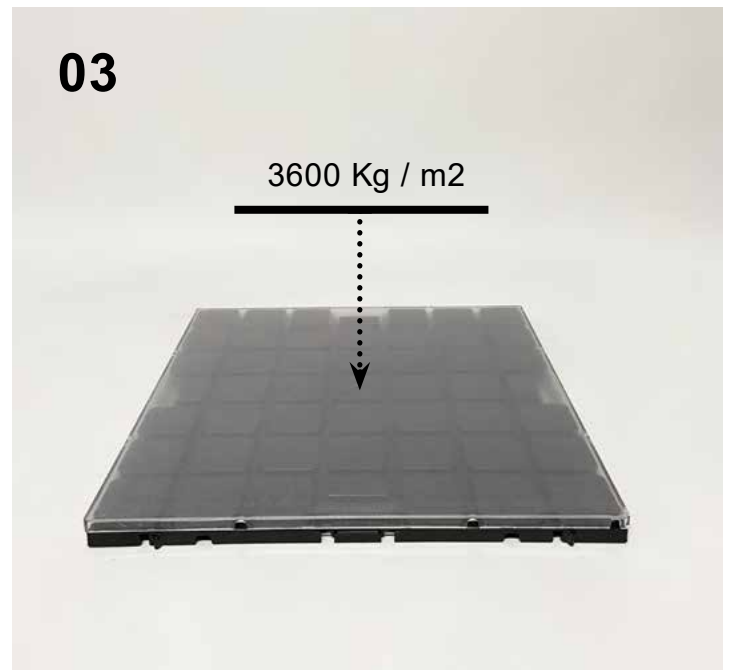

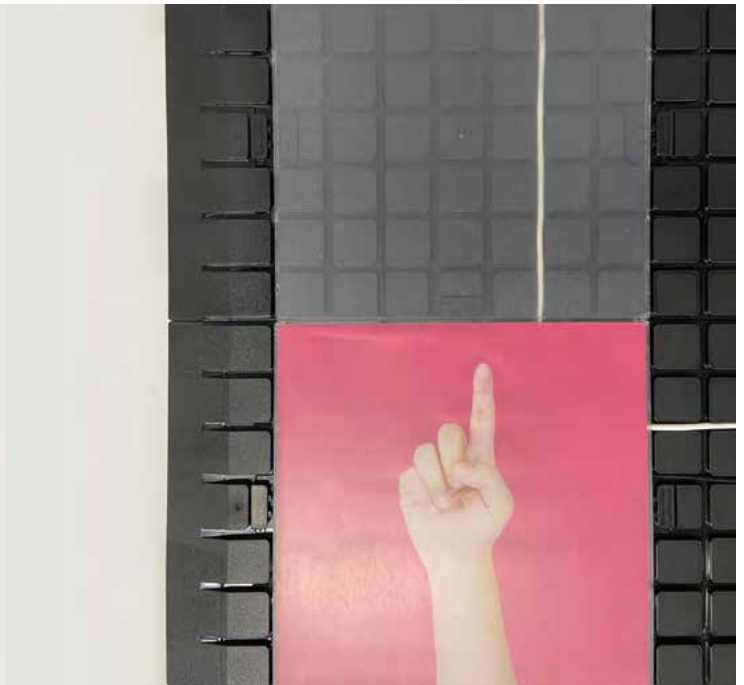
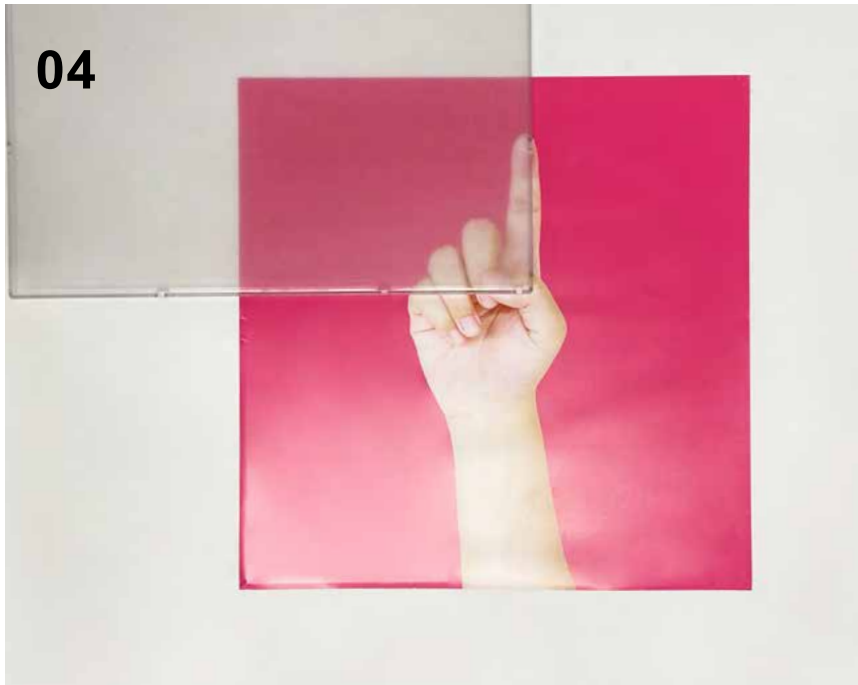



A 3LM reserva o direito de modificar este documento ou os produtos nele contidos, sem aviso prévio.
Todas as informações contidas neste documento, são fornecidas e são meramente orientativas e não vinculativas.
A 3LM não tem qualquer responsabilidade sobre a informação prestada neste documento, nem sobre a consequência do seu uso.

3LM PUBLICIDADE E IMAGEM
Rua 4 de julho, arm 10
3025-010 Portugal

(+351) 239 983 322
3lm@3lm.pt

3lm.pt

3LM*

3lm.pt