

Modulate™ Straight 1820

MOD-S-1820



Modulate™ consiste num conjunto de molduras em tubos de alumínio (Ø30 mm) cobertos por um têxtil impresso. Estas molduras conectam-se entre si com poderosos ímãs existentes em cada elemento. A gama Modulate está disponível em várias formas e 11 tamanhos diferentes.

- O exclusivo sistema **MagLink**, já existente na estrutura, permite-lhe conectar as molduras entre si apenas com um toque.
- Com o sistema **Twist & Lock**, posicione o pé por baixo da estrutura e rode até bloquear.
- As imagens são de fácil manutenção graças à utilização de têxtil anti-vincos e lavável à máquina.

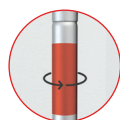

Conector MagLink 360° em cada secção. 4 ímãs por estrutura



Extensão opcional de 400 mm para modificar a altura da estrutura

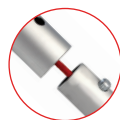

Sistema de auto-bloqueio através de mastros com elásticos internos e botões de pressão



Sistema de numeração em cada secção para fácil montagem



Tubo de reforço central (18 mm de diâmetro)



2 pés estabilizadores com sistema de rotação e bloqueio (Twist & Lock) fornecido em cada moldura



Cobertura têxtil de dupla-face Sistema de fecho zip



Saco de transporte **Modulate™** com compartimentos específicos para os pés e imagem gráfica

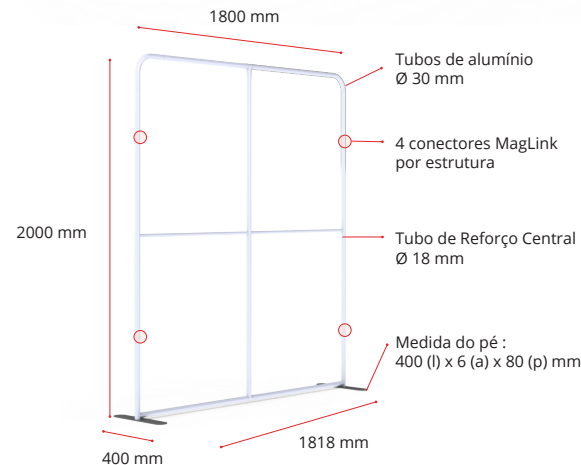

Especificações :

Produto	Modulate Straight 1820
Referência	MOD-S-1820
Dimensões da estrutura	1818 (l) x 2000 (a) x 400 (p) mm
Área gráfica visível	1800 (l) x 1982 (a) mm
Dimensão da embalagem	1000 (l) x 245 (a) x 125 (p) mm
Peso da estrutura	7.80 kg
Peso da estrutura embalada	8.18 kg

OPCIONAIS :



Modulate Meio-Pé (par)
MOD-HALF-FOOT-P
218 (l) x 6 (a) x 80 (p) mm



Kit de Extensão
MOD-EXT400MM
3 tubos



Spot LED Flood
LED-FLOOD-ARM-BDLK



Spot LED Strip
LED-STRIP-ARM-BDLK



Suporte de focos para mastros de Ø 30 mm
US903

«MIX & MATCH» AS 11 ESTRUTURAS MODULATE :

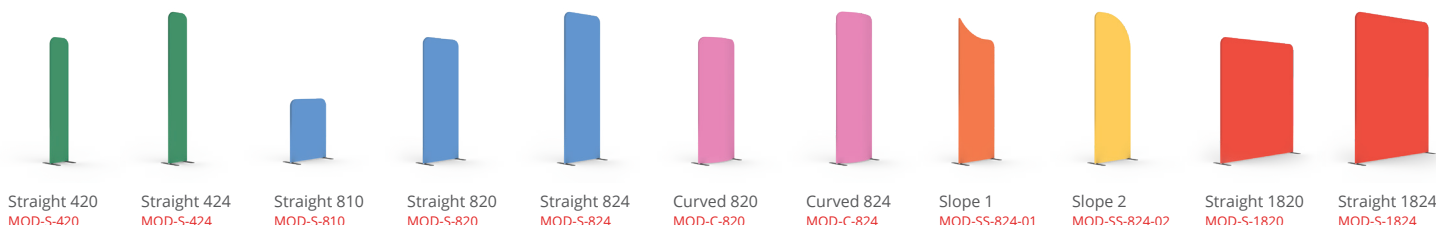

Straight 420
MOD-S-420

Straight 424
MOD-S-424

Straight 810
MOD-S-810

Straight 820
MOD-S-820

Straight 824
MOD-S-824

Curved 820
MOD-C-820

Curved 824
MOD-C-824

Slope 1
MOD-SS-824-01

Slope 2
MOD-SS-824-02

Straight 1820
MOD-S-1820

Straight 1824
MOD-S-1824

Modulate™ Straight 1820

MOD-S-1820



ELEMENTOS

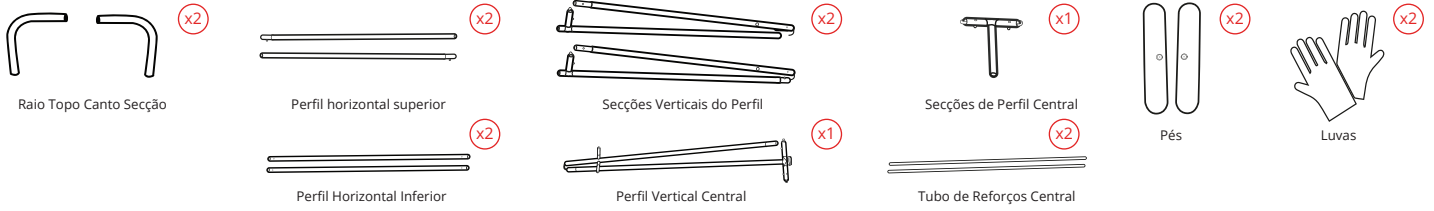

MONTAGEM

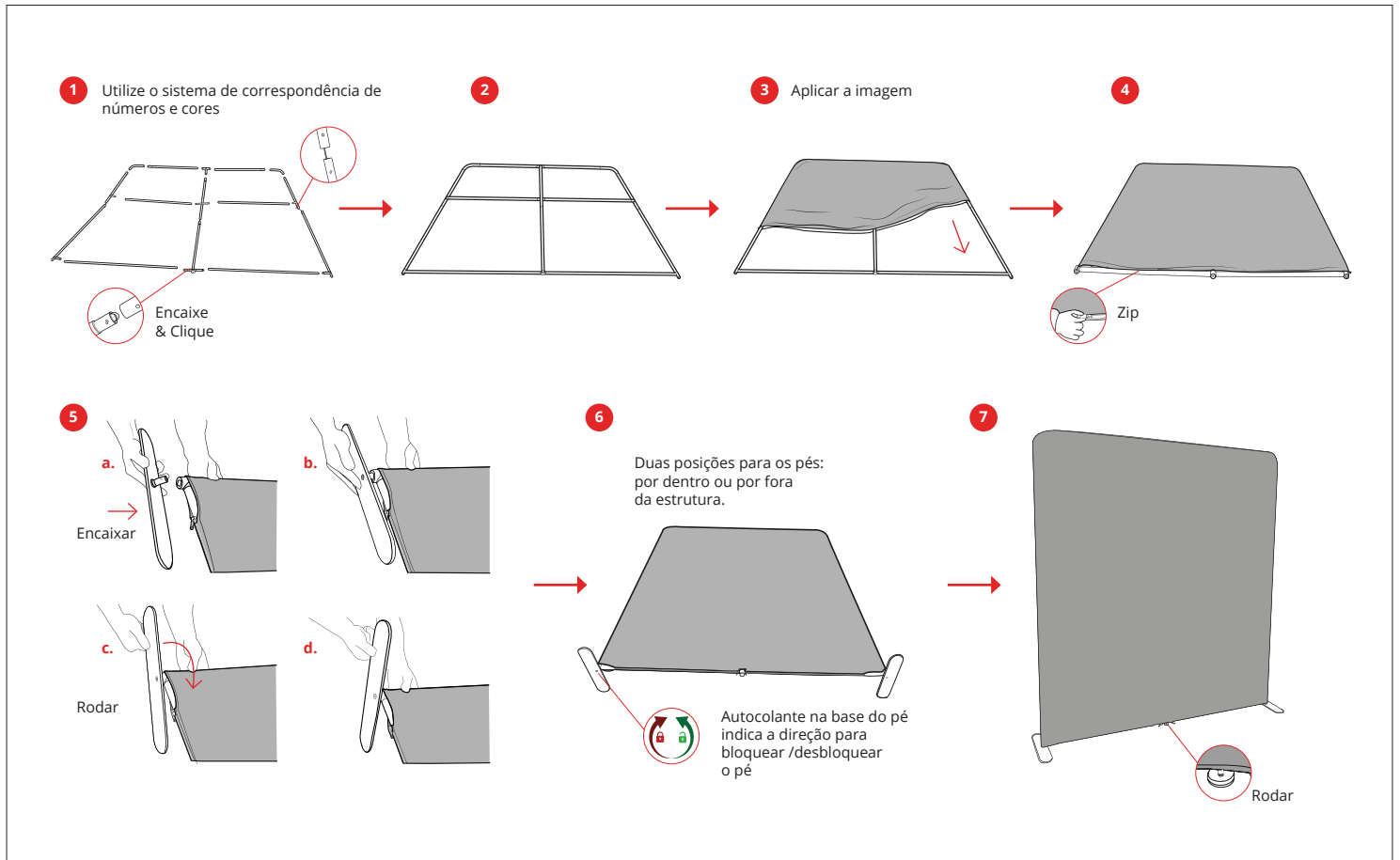

KIT DE EXTENSÃO (OPCIONAL)

2000 MM → 2400 MM

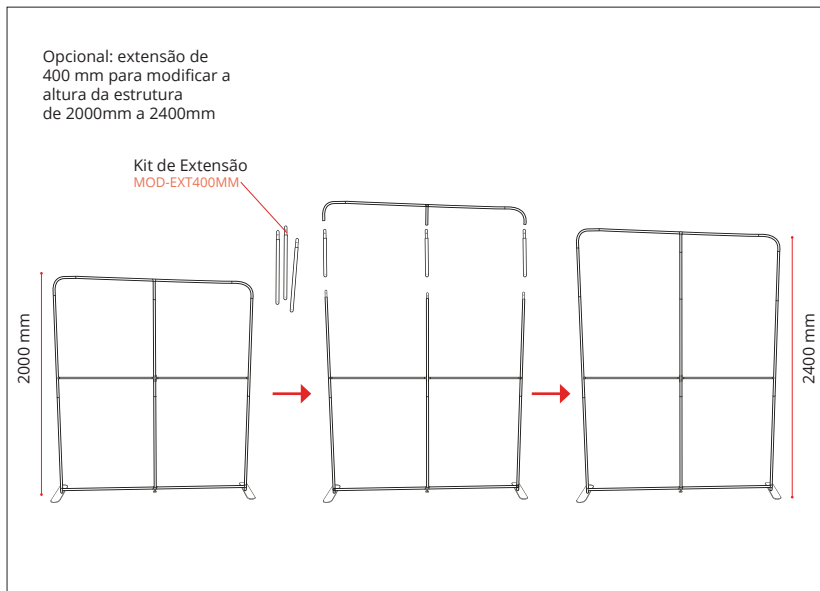

CONECTAR DIFERENTES ESTRUTURAS

Remova um pé da segunda estrutura e alinhe ambas as estruturas num pé

