

# Modulate™ Direito 2020

MOD-S-2020



**Modulate™** consiste num conjunto de molduras em tubos de alumínio (Ø30 mm) cobertos por um têxtil impresso. Estas molduras conectam-se entre si com poderosos ímãs existentes em cada elemento. A gama Modulate está disponível em várias formas e 15 tamanhos diferentes.

- O exclusivo sistema **MagLink**, já existente na estrutura, permite-lhe conectar as molduras entre si apenas com um toque.
- Com o sistema **Twist & Lock**, posicione o pé por baixo da estrutura e rode até bloquear.
- As imagens são de fácil manutenção graças à utilização de têxtil anti-vincos e lavável à máquina a 30°.

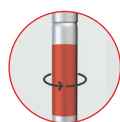

Conector MagLink 360° em cada secção. 4 ímãs por estrutura



Extensão opcional de 400 mm para modificar a altura da estrutura



Sistema de auto-bloqueio através de mastros com elásticos internos e botões de pressão



Sistema de numeração em cada secção para fácil montagem



Tubo de reforço central (18 mm de diâmetro)



2 pés estabilizadores com sistema de rotação e bloqueio (Twist & Lock) fornecido em cada moldura



Cobertura têxtil de dupla-face Sistema de fecho zip



Saco de transporte **Modulate™** com compartimentos específicos para os pés e imagem gráfica



Especificações :	
Produto	Modulate Direito 2020
Referência	MOD-S-2020
Dimensões da estrutura	2018 (l) x 2000 (a) x 400 (p) mm
Área gráfica visível	2000 (l) x 1982 (a) mm
Dimensão da embalagem	1030 (l) x 245 (a) x 135 (p) mm
Peso da estrutura	7.90 kg
Peso da embalagem	8.10 kg

Também disponível com ângulos retos: kit MOD-S-2020-SQ (os ângulos arredondados estão incluídos por defeito)

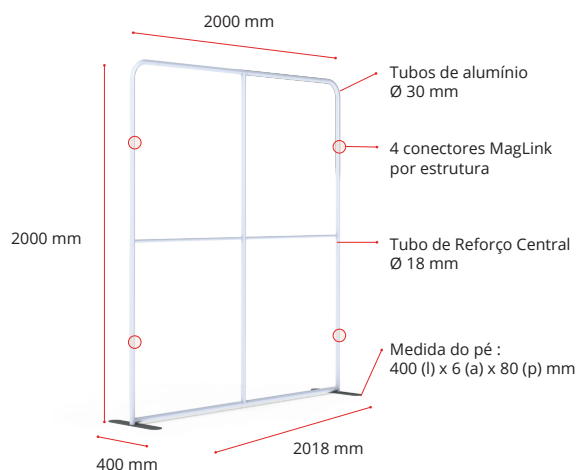

## OPCIONAIS :



Modulate Meio-Pé (par)  
MOD-HALF-FOOT-P

215 (L) x 6 (A) x 80 (P) mm



Kit de Extensão  
MOD-EXT400MM

3 tubos



POWERSPOT Spot 950-1000 LED  
PS950-1000-LED-BDLK



Suporte de focos para mastros de Ø30 mm  
US903



Ângulos retos (X2)  
MOD-SQ-ANGLE

## «MIX & MATCH» ESTRUTURAS MODULATE :



Direito 420  
MOD-S-420

Direito 424  
MOD-S-424

Direito 810  
MOD-S-810

Direito 820  
MOD-S-820

Direito 824  
MOD-S-824

Direito 1020  
MOD-S-1020

Direito 1024  
MOD-S-1024



Direito 1820  
MOD-S-1820

Direito 1824  
MOD-S-1824



Direito 2020  
MOD-S-2020

Direito 2024  
MOD-S-2024



Curvo 820  
MOD-C-820

Curvo 824  
MOD-C-824

Slope 1  
MOD-SS-824-01

Slope 2  
MOD-SS-824-02

## TAMBÉM DISPONÍVEL COM ÂNGULOS RETOS:

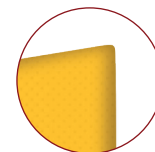

# Modulate™ Direito 2020

MOD-S-2020



## ELEMENTOS



Secções de topo com cantos arredondados



Secção horizontal superior

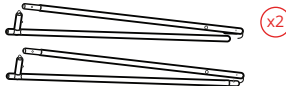

Secções Verticais



Conector

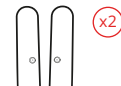

Pés



Luvas



Secção Horizontal Inferior



Secção Vertical Central



Tubo de reforço vertical

## MONTAGEM

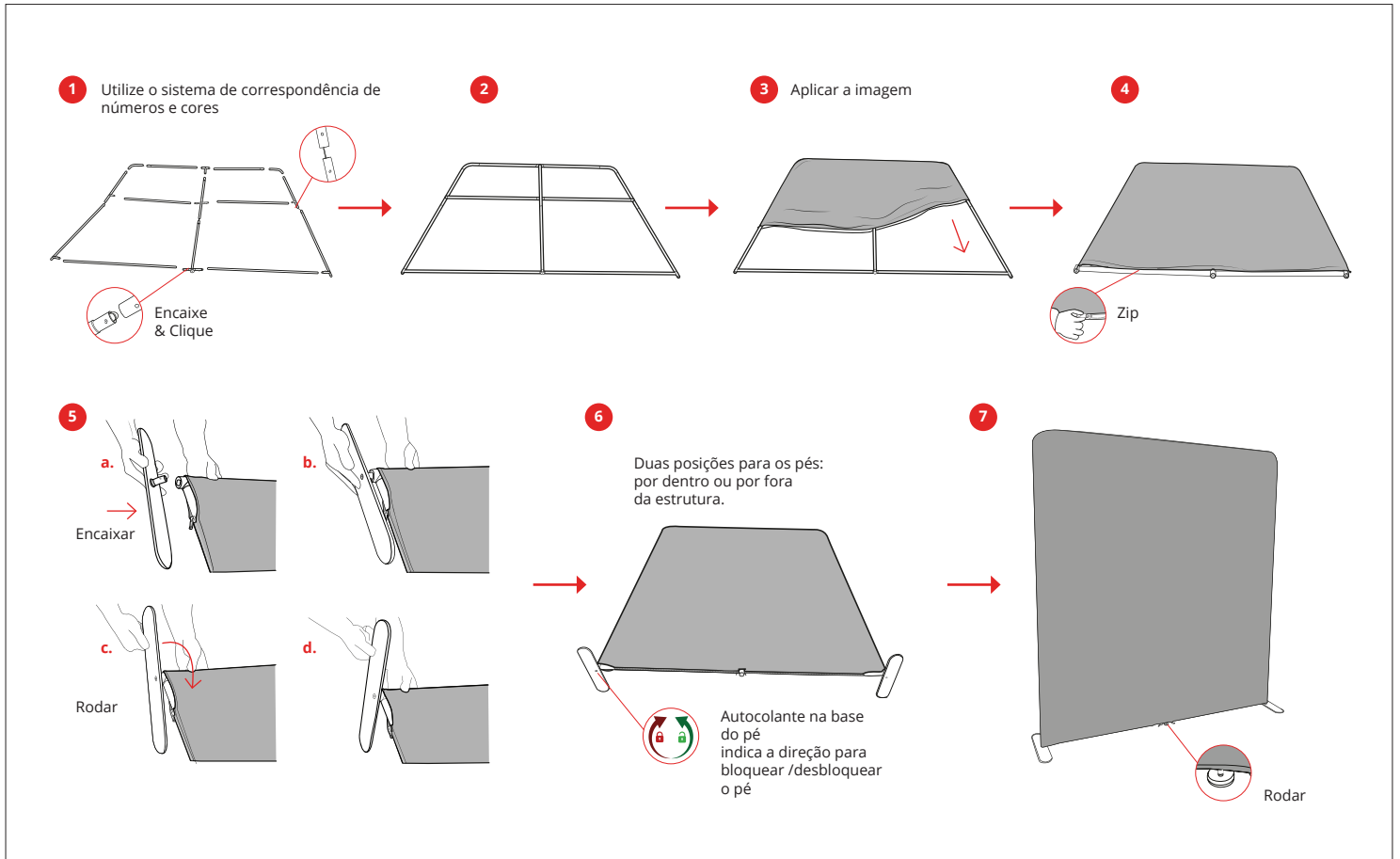

## KIT DE EXTENSÃO (OPCIONAL)

2400 MM → 2000 MM

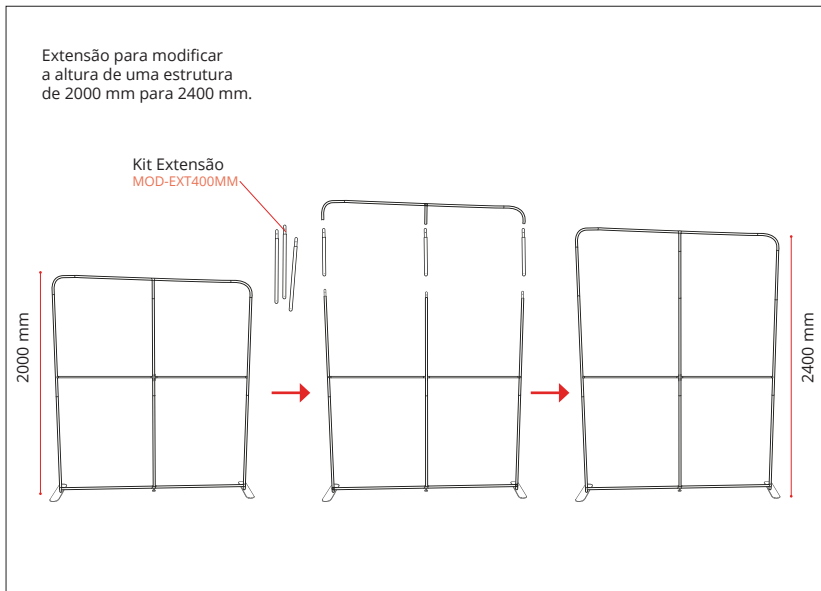

## CONECTAR DIFERENTES ESTRUTURAS

Remova um pé da segunda estrutura e alinhe ambas as estruturas num pé

